

Qty.	Description
1	<p data-bbox="196 159 560 188">CM 1-4 A-R-G-V-AQV F-A-A-N</p>  <p data-bbox="592 506 1062 528" style="text-align: center;">Note! Product picture may differ from actual product</p> <p data-bbox="196 539 480 562">Product No.: On request</p> <p data-bbox="196 600 1463 674">Compact, reliable, horizontal, multistage, end-suction centrifugal pump with axial suction port and radial discharge port. Pump materials in contact with the liquid are in high-grade stainless steel. The mechanical shaft seal is a special designed, unbalanced O-ring seal. Pipework connection is via internal Whitworth pipe threads, Rp (ISO 7/1).</p> <p data-bbox="196 712 1070 734">The pump is fitted with a 3-phase, foot-mounted, fan-cooled asynchronous motor.</p> <p data-bbox="196 772 300 795">Controls:</p> <p data-bbox="196 801 635 824">Frequency converter: NONE</p> <p data-bbox="196 862 276 884">Liquid:</p> <p data-bbox="196 891 635 913">Pumped liquid: Water</p> <p data-bbox="196 920 691 943">Liquid temperature range: -20 .. 90 °C</p> <p data-bbox="196 949 635 972">Selected liquid temperature: 20 °C</p> <p data-bbox="196 978 699 1001">Density: 998.2 kg/m³</p> <p data-bbox="196 1039 316 1061">Technical:</p> <p data-bbox="196 1068 818 1090">Pump speed on which pump data are based: 2900 rpm</p> <p data-bbox="196 1097 659 1120">Rated flow: 1.7 m³/h</p> <p data-bbox="196 1126 659 1149">Rated head: 25.13 m</p> <p data-bbox="196 1155 643 1178">Code for shaft seal: AQVQ</p> <p data-bbox="196 1184 730 1207">Approvals: CE,EAC,UKCA</p> <p data-bbox="196 1214 834 1236">Approvals for drinking water: WRAS,ACS,NSF61,UBA</p> <p data-bbox="196 1243 762 1265">Curve tolerance: ISO9906:2012 3B</p> <p data-bbox="196 1303 308 1326">Materials:</p> <p data-bbox="196 1332 722 1422">Pump housing: Stainless steel EN 1.4401 AISI 316</p> <p data-bbox="196 1429 722 1518">Impeller: Stainless steel EN 1.4401 AISI 316</p> <p data-bbox="196 1556 323 1579">Installation:</p> <p data-bbox="196 1585 691 1608">Range of ambient temperature: -20 .. 55 °C</p> <p data-bbox="196 1615 643 1637">Maximum operating pressure: 16 bar</p> <p data-bbox="196 1644 722 1688">Max pressure at stated temp: 16 bar / 90 °C 16 bar / 90 °C</p> <p data-bbox="196 1695 595 1718">Type of connection: Rp</p> <p data-bbox="196 1724 635 1747">Size of inlet connection: 1 inch</p> <p data-bbox="196 1753 635 1776">Size of outlet connection: 1 inch</p> <p data-bbox="196 1783 595 1805">Outlet position: 12</p> <p data-bbox="196 1843 363 1865">Electrical data:</p> <p data-bbox="196 1872 611 1895">Motor standard: IEC</p> <p data-bbox="196 1901 611 1924">Frame size: 71A</p> <p data-bbox="196 1930 659 1953">Rated power - P2: 0.46 kW</p> <p data-bbox="196 1960 635 1982">Mains frequency: 50 Hz</p> <p data-bbox="196 1989 579 2011">Suitable for 50/60 Hz: N</p> <p data-bbox="196 2018 850 2040">Rated voltage: 3 x 220-240D/380-415Y V</p> <p data-bbox="196 2047 611 2069">Service factor: 1.00</p> <p data-bbox="196 2076 746 2098">Rated current: 2,0-2,2/1,0-1,2 A</p>

Qty.	Description
1	<p>Starting current: 490-530 % Rated speed: 2770-2820 rpm Enclosure class (IEC 34-5): IP55 Insulation class (IEC 85): F Built-in motor protection: NONE Cable included (Yes/No): N</p> <p>Others: Terminal box position: 12 Minimum efficiency index, MEI ≥: 0.68 Net weight: 12 kg Gross weight: 14.5 kg Country of origin: TW Custom tariff no.: 84137042</p>

On request CM 1-4 A-R-G-V-AQQV F-A-A-N 50 Hz

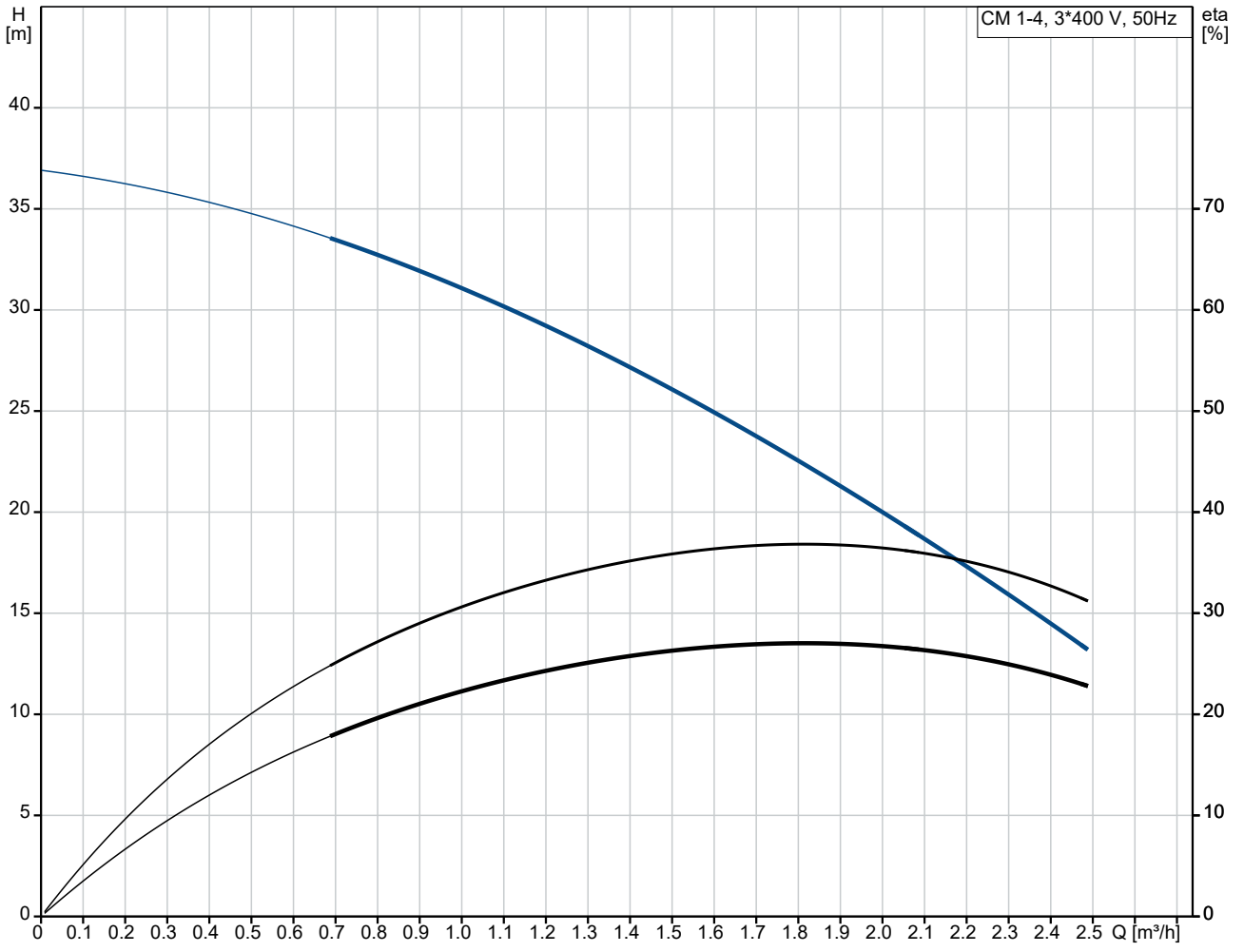

Pumped liquid = Water
 Liquid temperature during operation = 20 °C
 Density = 998.2 kg/m³

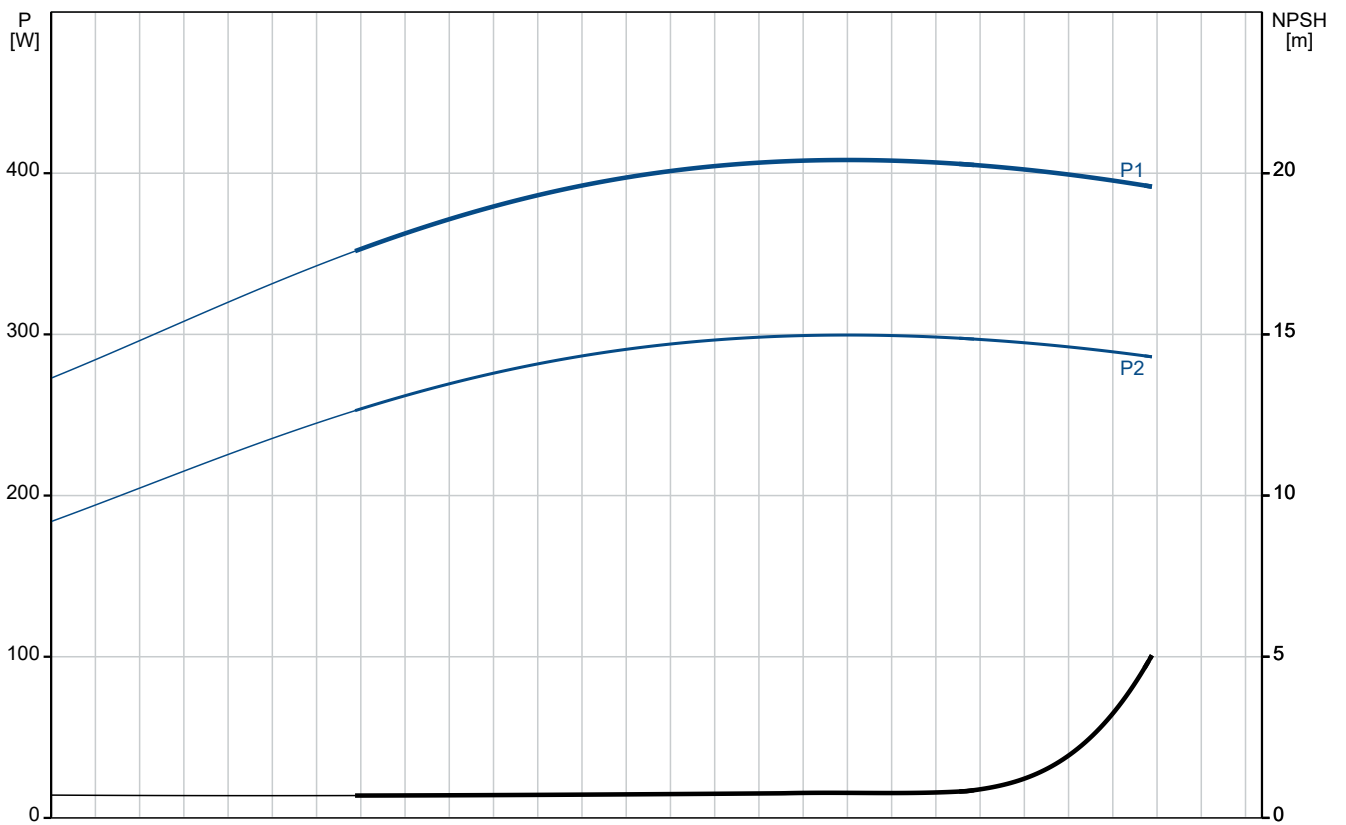

Description	Value
General information:	
Product name:	CM 1-4 A-R-G-V-AQQV F-A-A-N
Product No:	On request
EAN number:	On request
Technical:	
Pump speed on which pump data are based:	2900 rpm
Rated flow:	1.7 m ³ /h
Rated head:	25.13 m
Impellers:	4
Code for shaft seal:	AQQV
Approvals:	CE,EAC,UKCA
Approvals for drinking water:	WRAS,ACS,NSF61,UBA
Curve tolerance:	ISO9906:2012 3B
Pump version:	A
Model:	A
Materials:	
Pump housing:	Stainless steel
Pump housing:	EN 1.4401
Pump housing:	AISI 316
Impeller:	Stainless steel
Impeller:	EN 1.4401
Impeller:	AISI 316
Material code:	G
Code for rubber:	V
Installation:	
Range of ambient temperature:	-20 .. 55 °C
Maximum operating pressure:	16 bar
Max pressure at stated temp:	16 bar / 90 °C
Max pressure at stated temp:	16 bar / 90 °C
Type of connection:	Rp
Size of inlet connection:	1 inch
Size of outlet connection:	1 inch
Outlet position:	12
Connect code:	R
Liquid:	
Pumped liquid:	Water
Liquid temperature range:	-20 .. 90 °C
Selected liquid temperature:	20 °C
Density:	998.2 kg/m ³
Electrical data:	
Motor standard:	IEC
Frame size:	71A
Rated power - P2:	0.46 kW
Mains frequency:	50 Hz
Suitable for 50/60 Hz:	N
Rated voltage:	3 x 220-240D/380-415Y V
Service factor:	1.00
Rated current:	2,0-2,2/1,0-1,2 A
Starting current:	490-530 %
Rated speed:	2770-2820 rpm
Enclosure class (IEC 34-5):	IP55
Insulation class (IEC 85):	F
Built-in motor protection:	NONE
Cable included (Yes/No):	N
Controls:	
Frequency converter:	NONE
Others:	
Terminal box position:	12
Minimum efficiency index, MEI ≥:	0.68
Net weight:	12 kg
Gross weight:	14.5 kg
Country of origin:	TW

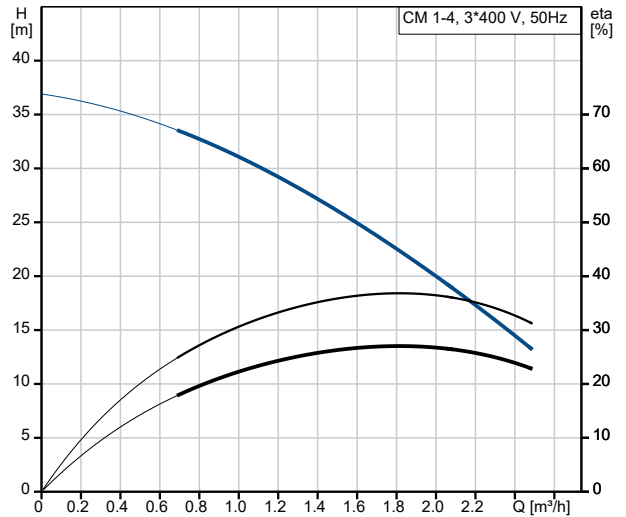

Pumped liquid = Water
Liquid temperature during operation = 20 °C
Density = 998.2 kg/m³

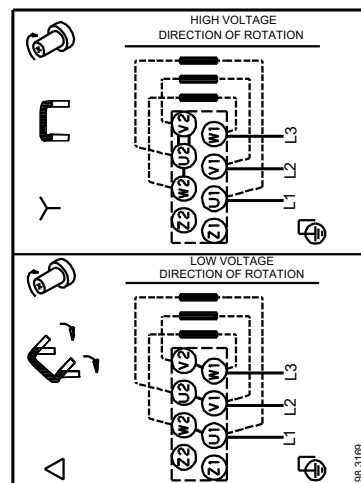
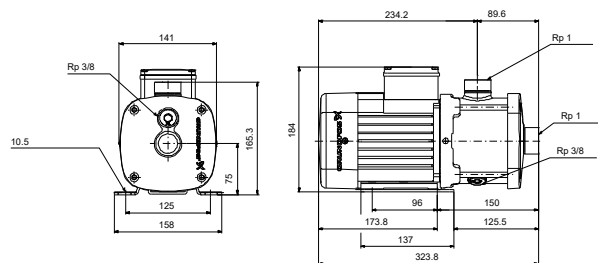
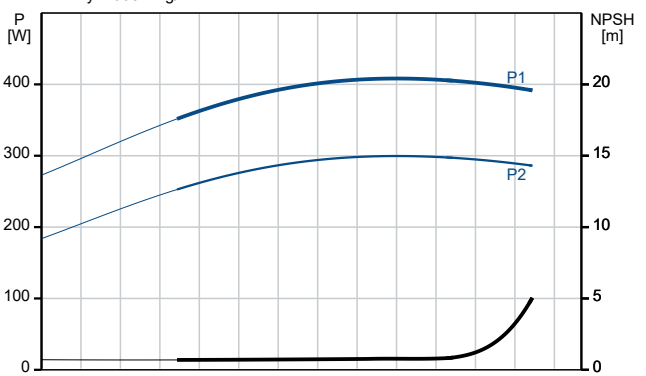

Description**Value**

Custom tariff no.:

84137042

On request CM 1-4 A-R-G-V-AQQV F-A-A-N 50 Hz

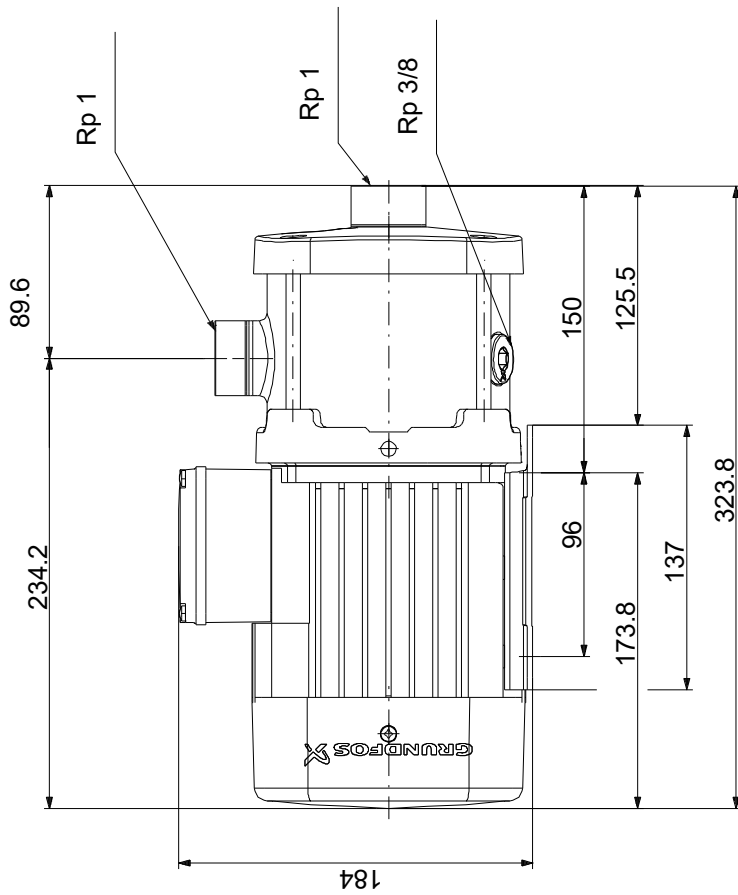

Note! All units are in [mm] unless others are stated.
 Disclaimer: This simplified dimensional drawing does not show all details.